

Not recommended when air test is needed

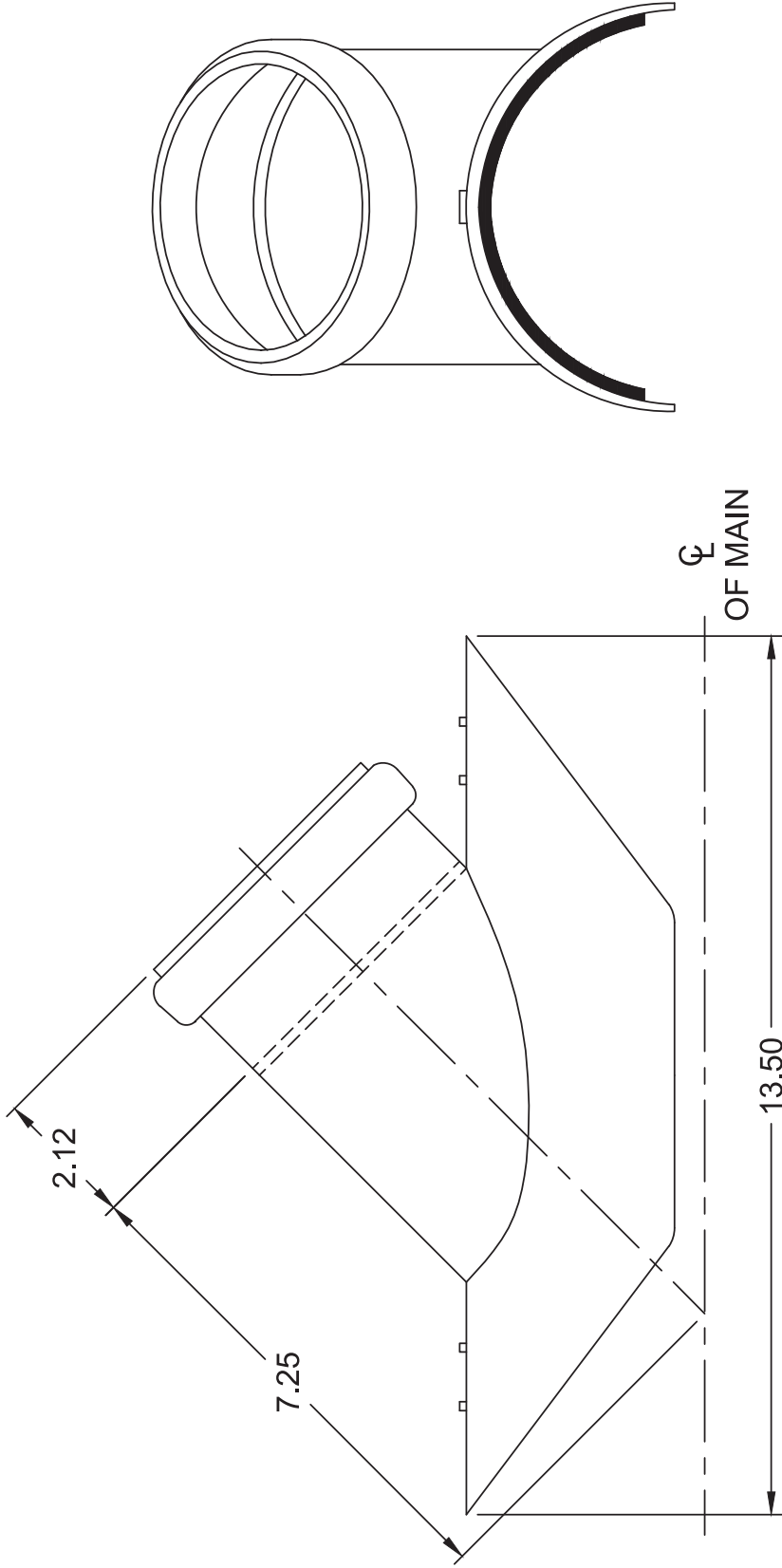

FOR REFERENCE ONLY DIMENSIONS IN INCHES DIMENSIONS SUBJECT TO CHANGE

TITLE

6" x 4" SADDLE WYE GxG WITH STRAPS  
D3034/F1336 SDR 35 PSM PVC

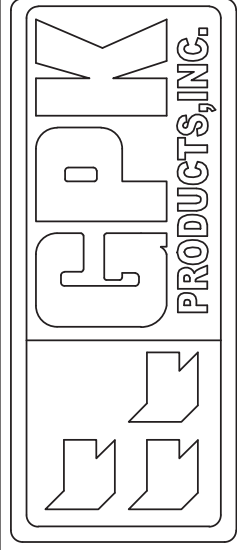

1-800-437-4670 FARGO, ND

DATE 1-15-15

SCALE NONE

PART NO.

135-0064