

Not recommended when air test is needed

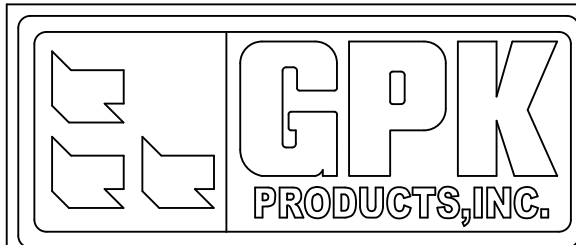
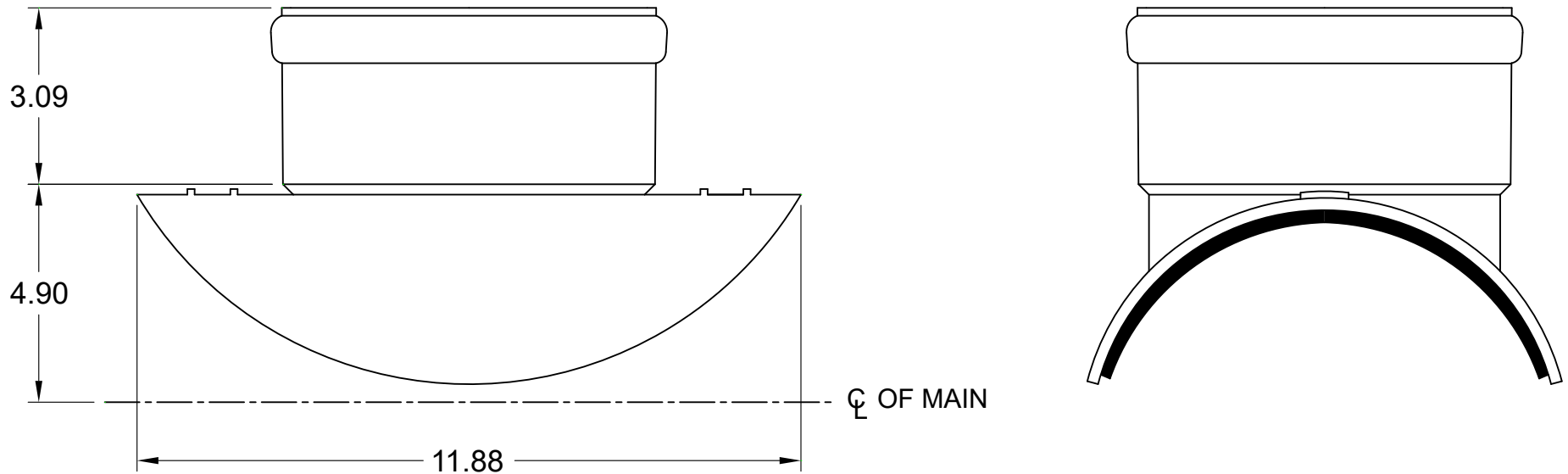

FOR REFERENCE ONLY DIMENSIONS IN INCHES DIMENSIONS SUBJECT TO CHANGE

TITLE

8" x 6" SADDLE TEE GxG WITH STRAPS
D3034/F1336 SDR 35 PSM PVC

1-800-437-4670 FARGO, ND

DATE 5-6-16

SCALE NONE

PART NO. 136-0086